

MR 295 H16

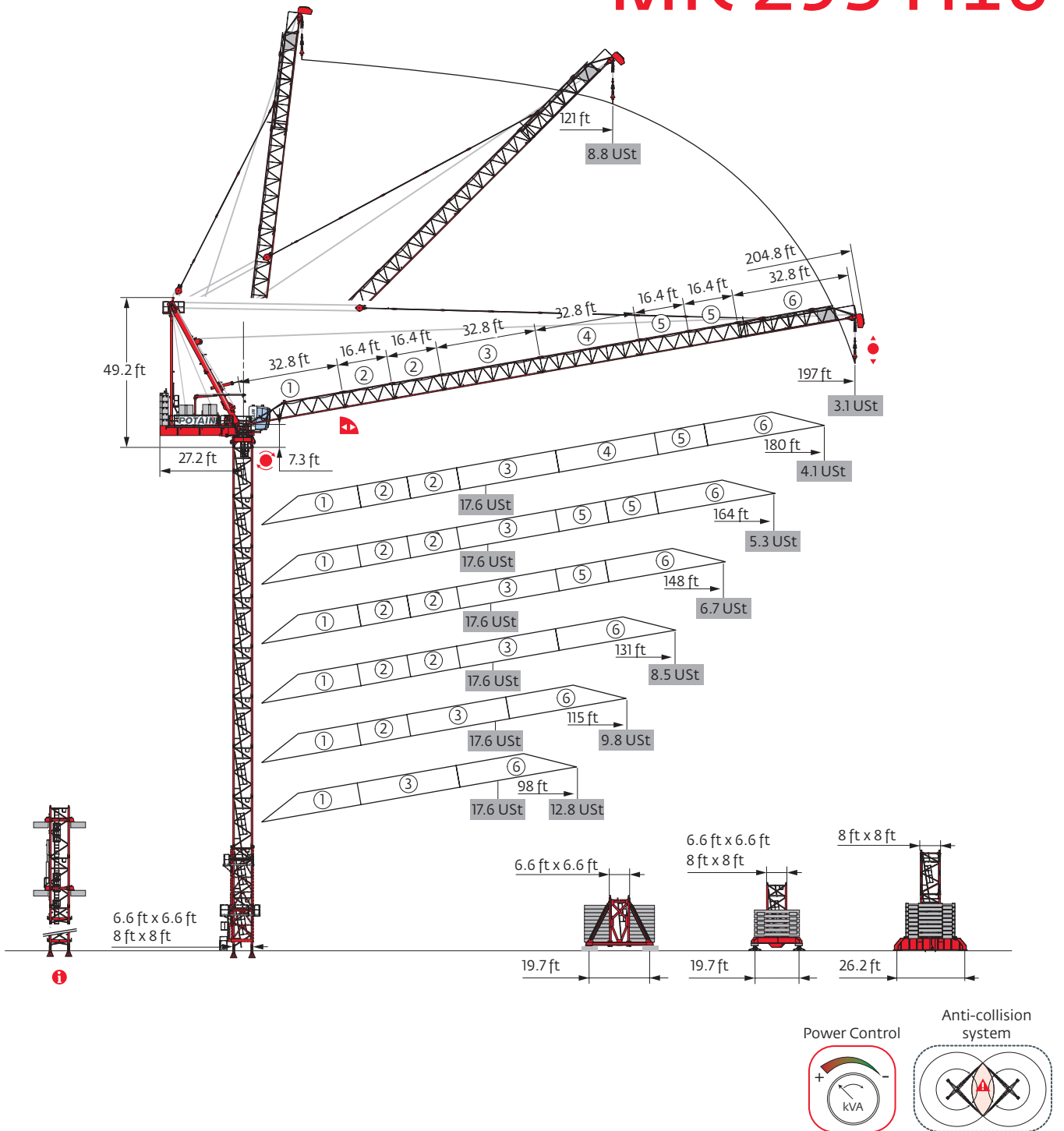

Mast - Reactions

6.6 ft - P 602B

Height (ft)	98	115	131	148	164	180	197
Height (ft)	183.4	177.8	172.2	161.4	150.6	145	139.4
10.9 ft	1	2	0	2	1	2	0
16.4 ft	10	9	10	8	8	7	8
F2 (Ust)	● 261	256	251	249	247	242	235
	■ 326	346	360	357	355	367	362
F3 (Ust)	● 206	201	197	184	183	181	176
	■ 271	291	306	304	302	315	311

6.6 ft - V 60A

Height (ft)	98	115	131	148	164	180	197
Height (ft)	164.7	148.3	137.1	126.3	115.5	104.3	93.5
10.9 ft	1	1	0	2	1	0	2
16.4 ft	8	7	7	5	5	5	3
F1 (Ust)	● 124	123	124	124	123	123	115
	■ 141	135	133	132	129	127	125

6.6 ft - ZX 6830

Height (ft)	98	115	131	148	164	180	197
Height (ft)	186.4	175.5	164.4	153.5	142.7	131.6	120.7
10.9 ft	1	0	2	1	0	2	1
16.4 ft	10	10	8	8	8	6	6
F1 (Ust)	● 141	144	147	147	143	146	134
	■ 173	175	175	172	169	168	164

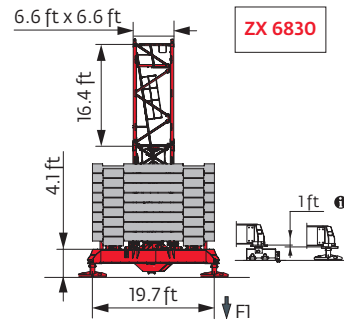
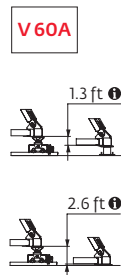
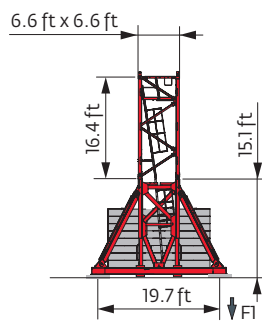
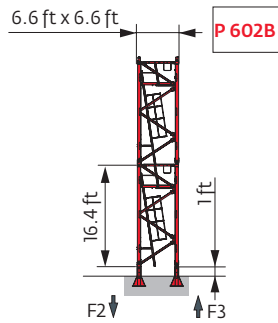

8 ft - P 802B

WIND (ft)	98	115	131	148	164	180	197
\bar{r} (ft)	217.2	206.4	195.2	190	178.8	173.6	168
6.6 ft	1	1	1	1	1	1	1
	2	1	0	1	0	1	2
	11	11	11	10	10	9	8
F2 (Ust)	● 262	251	239	235	232	228	222
	■ 400	395	388	399	392	402	399
F3 (Ust)	● 195	186	176	160	158	156	152
	■ 333	331	324	336	329	339	336

8 ft - ZX 6830

WIND (ft)	98	115	131	148	164	180	197
\bar{r} (ft)	176.5	165.7	154.5	143.7	138.1	127.3	116.5
6.6 ft	1	1	1	1	1	1	1
	1	0	2	1	2	1	0
	9	9	7	7	6	6	6
F1 (Ust)	● 142	145	146	145	146	145	136
	■ 177	176	176	170	176	171	166

8 ft - ZY 800

WIND (ft)	98	115	131	148	164	180	197
\bar{r} (ft)	210.6	199.8	194.2	183.4	177.8	167	161.4
6.6 ft	1	1	1	1	1	1	1
	1	0	1	0	1	0	1
	11	11	10	10	9	9	8
F1 (Ust)	● 141	143	148	143	147	146	138
	■ 194	191	198	191	196	190	195

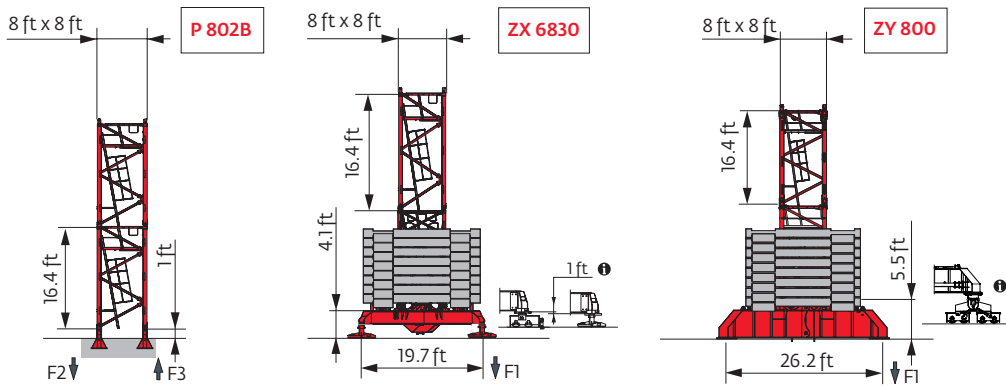

Note: When "ASCE" is noted in this data sheet it is referring to 115 mph Wind Zone, Exposure B, Design Wind Speed = 98 mph. See back cover for design wind speed calculations.

i Motorized accesses: adapted mast compositions, base ballast and reactions.

Anchorage

i

Base ballast

USt / 6.6 ft - V 60A

(ft)	98	115	131	148	164	180	197
164.7	145.5						
148.3	119.1	145.5					
137.1	105.8	119.1	145.5				
126.3	105.8	105.8	119.1	145.5			
115.5	105.8	105.8	105.8	119.1	145.5		
104.3	105.8	105.8	105.8	105.8	119.1	145.5	
93.5	105.8	105.8	105.8	105.8	105.8	119.1	145.5
77.1	105.8	105.8	105.8	105.8	105.8	105.8	105.8

USt / 6.6 ft - ZX 6830

(ft)	98	115	131	148	164	180	197
186.4	177.5						
175.5	155.4	188.5					
164.4	133.4	166.5	199.5				
153.5	111.3	144.4	166.5	199.5			
142.7	100.3	111.3	144.4	166.5	188.5		
131.6	100.3	100.3	122.4	144.4	166.5	199.5	
120.7	100.3	100.3	100.3	122.4	144.4	166.5	188.5
104.3	100.3	100.3	100.3	100.3	100.3	133.4	155.4
87.9	100.3	100.3	100.3	100.3	89.3	100.3	111.3

USt / 8 ft - ZX 6830

(ft)	98	115	131	148	164	180	197
176.5	188.5						
165.7	166.5	199.5					
154.5	133.4	166.5	199.5				
143.7	111.3	144.4	166.5	199.5			
138.1	111.3	122.4	155.4	177.5	199.5		
127.3	111.3	100.3	122.4	155.4	177.5	199.5	
116.5	111.3	100.3	100.3	122.4	144.4	166.5	199.5
100.1	111.3	100.3	100.3	100.3	111.3	133.4	155.4
83.7	111.3	100.3	100.3	100.3	100.3	100.3	111.3

USt / 8 ft - ZY 800

(ft)	98	115	131	148	164	180	197
210.6	172						
199.8	158.7	185.2					
194.2	145.5	172	198.4				
183.4	119.1	145.5	172	185.2			
177.8	105.8	132.3	158.7	172	198.4		
167	92.6	119.1	132.3	158.7	172	198.4	
161.4	79.4	105.8	119.1	145.5	158.7	185.2	198.4
145	52.9	79.4	92.6	105.8	132.3	145.5	172
128.6	39.7	39.7	66.1	79.4	92.6	119.1	132.3
112.2	39.7	39.7	39.7	52.9	66.1	92.6	105.8
95.8	39.7	39.7	39.7	39.7	39.7	52.9	79.4

Load curves

8.8 USt

(ft)	72	82	89	98	102	105	115	118	121	131	134	138	148	149	154	164	165	171	180	181	187	197	ft	
197	16 → 121																							USt
180	15 → 124	8.8	8.8	8.8	8.8	8.8	8.8	8.8	8.8	8.8	7.6	-	6.9	6.1	-	5.5	4.7	-	4.3	3.6	-	3.4	3.1	USt
164	14 → 125	8.8	8.8	8.8	8.8	8.8	8.8	8.8	8.8	8.8	8.2	-	7.4	6.5	-	6.2	5.3	5.2	USt					
148	13 → 126	8.8	8.8	8.8	8.8	8.8	8.8	8.8	8.8	8.8	8.3	-	7.7	6.7	6.5	USt								
131	12 → 129	8.8	8.8	8.8	8.8	8.8	8.8	8.8	8.8	8.8	8.5	8.2	USt											
115	11 → 118	8.8	8.8	8.8	8.8	8.8	8.8	8.8	8.8	USt														
98	10 → 102	8.8	8.8	8.8	8.8	8.8	USt																	

13.2 USt

(ft)	56	66	72	82	92	98	102	105	115	118	121	131	134	138	148	149	154	164	165	171	180	181	ft	
180	15 → 91	13.2	13.2	13.2	13.2	-	11.7	-	10.5	9	-	8.2	6.9	-	6.3	5.5	-	5.3	4.5	-	4.1	3.4	3.3	USt
164	14 → 92	13.2	13.2	13.2	13.2	13.2	11.8	-	10.7	-	-	8.3	7.2	-	6.5	5.8	-	5.3	4.5	4.4	USt			
148	13 → 92	13.2	13.2	13.2	13.2	13.2	12	-	10.8	9.3	8.8	-	7.6	-	6.8	5.8	5.7	USt						
131	12 → 93	13.2	13.2	13.2	13.2	13.2	12.1	-	11	9.3	-	-	7.6	7.4	USt									
115	11 → 94	13.2	13.2	13.2	13.2	13.2	12.5	-	11.2	9.8	9.4	USt												
98	10 → 96	13.2	13.2	13.2	13.2	13.2	12.8	12.1	USt															

17.6 USt and **8.8 USt**

(ft)	56	66	72	82	89	98	102	105	115	118	121	131	134	138	148	149	154	164	165	171	180	181	ft	
180	15 → 73	17.6	17.6	17.6	15	13.3	11.1	-	10	8.5	-	8.2	6.9	-	6.3	5.7	-	5.4	4.6	-	4.2	3.5	3.5	USt
164	14 → 74	17.6	17.6	17.6	15.1	13.4	11.4	-	10.1	-	-	8.3	7.2	-	6.6	6.1	-	5.5	4.6	4.6	USt			
148	13 → 74	17.6	17.6	17.6	15.3	13.6	11.5	-	10.4	8.8	8.8	-	7.7	-	7.1	6.1	5.9	USt						
131	12 → 75	17.6	17.6	17.6	15.4	13.8	11.7	-	10.5	9	-	-	7.8	7.6	USt									
115	11 → 76	17.6	17.6	17.6	15.8	14.1	12	-	10.7	9.7	9.2	USt												
98	10 → 77	17.6	17.6	17.6	16.1	14.3	12.6	11.9	USt															

USt = **USt** - 0.6 USt

Jib weight & counter-jib ballast

Height (ft)	Jib Weight (lb) (+/- 5%)			90 HPL™ - 100 LVF Counter-jib Ballast (lb)		
	U	U	U	8,708 lb	2,205 lb	U (lb)
197 ft	-	-	20,988	5	1	45,746
180 ft	20,745	20,216	19,709	5	1	45,746
164 ft	19,544	19,015	18,508	5	1	45,746
148 ft	18,232	17,703	17,196	5	0	43,541
131 ft	16,843	16,314	15,807	5	0	43,541
115 ft	15,102	14,573	14,065	5	0	43,541
98 ft	13,228	12,699	12,192	5	0	43,541

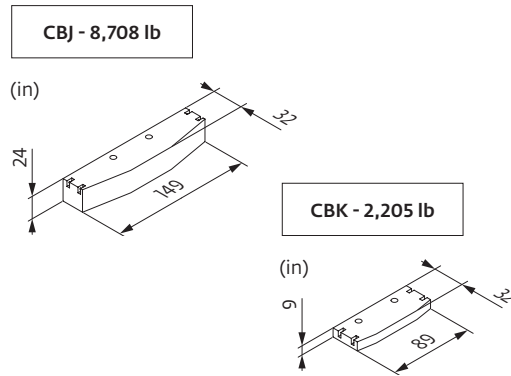

Luffing jib

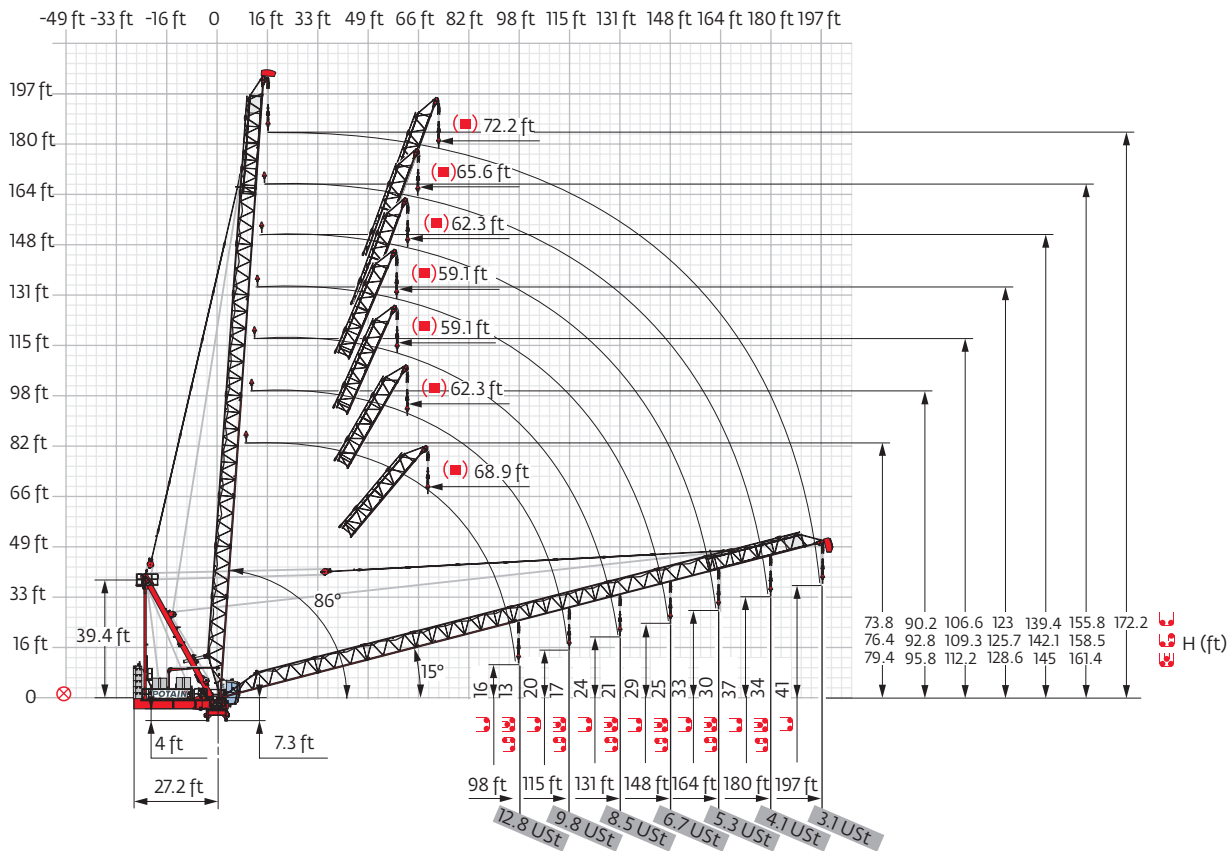





Dimensions and weight

Slewing crane part:  197 ft -  90 HPL™

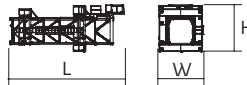
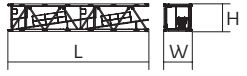

Slewing crane part		L (ft)	W (ft)	H (ft)	lb (+/- 5%)
Counter-jib		23.9	17.6	15.6	16,479
Strut		24.9	10.8	42.7	15,465
Cab	Ultra View	15.6	6.1	8.3	4,057
Towerhead	6.6 ft	9.8	7.5	10.3	20,172
Jib section	①	33.7	6.2	6.5	3,241
Jib section	② ⑤	17 17	5.9 5.9	5.5 5.4	1,433 1,168
Jib section	③ ④	33.4 33.4	5.9 5.9	5.5 5.4	2,712 2,338
Jib section	⑥	38.7	6	6.5	2,998
Pulley block		5.9 2	1.4 0.6	8.8 3.8	1,087 897
Hoisting winch (+ rope)	90 HPL™ 100 LVF	9.3 10.1	4.3 5.2	5.6 6.2	6,140 9,932
Luffing winch (+ rope)	100 VVF	10.4	5.8	6.2	6,614

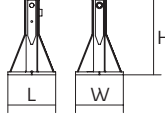
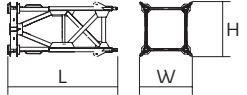
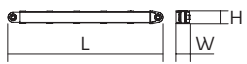
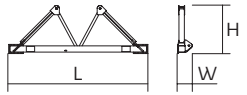
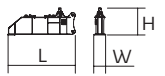
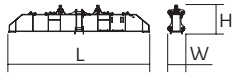
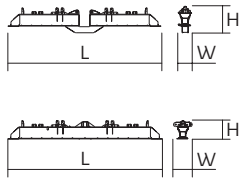
Crane tower			L (ft)	W (ft)	H (ft)	lb (+/- 5%)
T 61 T 851		□ 6.6 ft □ 8 ft	35.5 36.7	13.6 15.9	14.7 19	21,385 34,723
K 649B KM 649E		□ 6.6 ft □ 6.6 ft	33.6 33.8	6.8 6.7	6.7 6.7	11,663 10,692
K 649A KMT 649A KR 649A KRMT 649A K 849A KR 849A KMT 849A KRMT 849A		□ 6.6 ft □ 6.6 ft □ 6.6 ft □ 6.6 ft □ 8 ft □ 8 ft □ 8 ft □ 8 ft	17.2 17.2 17.2 17.2 17.2 17.2 17.2 17.2	6.8 6.8 6.9 6.8 8.3 8.3 8.4 8.3	6.7 6.7 6.8 6.8 8.2 8.2 8.3 8.3	6,184 5,666 7,165 6,724 7,496 9,458 6,945 9,017
K 649C KMT 649C KRMT 649C KRMT 849C		□ 6.6 ft □ 6.6 ft □ 6.6 ft □ 8 ft	11.7 11.7 11.7 11.7	6.8 6.8 6.9 8.4	6.7 6.7 6.8 8.3	4,376 4,542 5,401 7,066
K80/KR60-2 Connecting mast		□ 8/6.6 ft	7.3	10.7	8.1	8,852
Fixing angles		P 602B P 802B	2.1 2.5	2.1 2.5	4.2 4.2	761 1,025
Basic mast unit		V 60A	16.4	7.9	7.9	10,494
Struts		V 60A	14.8	1	1	1,036
Half-bearer		V 60A	22	2.3	7.6	4,057
1/2 Cross girder		ZY 800	18.6	3.2	6.3	10,406
Cross girder		ZY 800	39.2	4.6	6.3	22,212
Cross girder		ZX 6830	29.9 29.9	2.5 3.7	4.9 3.6	12,004 11,607

Mechanisms

480 V - 60 Hz													hp	kW	
	90 HPL™ 40	fpm	133	174	249	366	548	69	90	130	190	274	90	66	1,768 ft
		USt	8.8	6.6	4.4	2.2	0.6	17.6	13.2	8.8	4.4	1.5			
	100 LVF 40 Optima	fpm	146	187	249	325	382	76	98	131	171	192	100	75	3,727 ft
		USt	8.8	6.6	4.4	2.2	0.9	17.6	13.2	8.8	3.9	3			
	100 VVF 40		1 min 40 s									100	75		
	RVF 172 Optima+	rpm	0 → 0.8									2 x 10	2 x 7.5		

IEC 60204-32	kVA
480 V (+6% -10%) 60 Hz	90 HPL™ : 171 → 135 kVA 100 LVF : 179 kVA

100 LVF 40 Optima

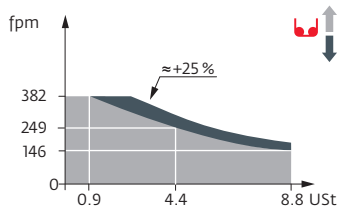

These mast combinations meet the EN 14439 and ASME B30.3-2016 specifications for “out of service” wind conditions, provided the illustrated wind speed matches required design wind speed for the location of the tower crane. The “out of service” design wind speed was determined in accordance with ASCE 7-10, Figure 26.5-1A. The wind velocity, used for this configuration was 98 mph (158 kph), which represents a nominal design 3-second wind gust at 33 ft (10 m) above ground for Exposure B category. A factor of 0.85 was applied to the 700-year ultimate design wind speed of 115 mph (185 kph), per ASCE 37-02, with the assumption that this crane is considered a temporary structure used during a construction period of 2 years or less.

- Standard equipment
- Options
- Reactions in service
- Reactions out of service
- Jib weight
- Jib articulation axis
- Weathering position
- Lorry 44 ft
- Container High Cube 40 ft, and/or Flat Rack 20 ft
- Hoisting
- Luffing
- Slewing
- Travelling
- Required power
- Power Control Function: winch speeds adapted to the available power
- Consult us

This commercial document is not legally binding. For any technical information, please refer to the corresponding instructions.

